

Single relay - REL-MR- 4,5DC/21 - 2961367

Please be informed that the data shown in this PDF Document is generated from our Online Catalog. Please find the complete data in the user's documentation. Our General Terms of Use for Downloads are valid (<http://phoenixcontact.com/download>)

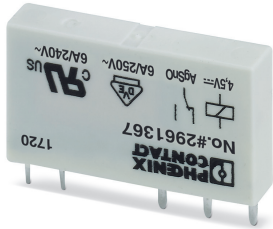

Plug-in miniature power relay, with power contact, 1 changeover contact, input voltage 4.5 V DC

Your advantages

- ✓ Safe isolation according to DIN EN 50178 between coil and contact
- ✓ High degree of protection up to RT III depending on type (wash-proof)
- ✓ Power contacts up to 6 A



Key Commercial Data

Packing unit	1 pc
Minimum order quantity	10 pc
GTIN	 4 017918 730840
GTIN	4017918730840
Weight per Piece (excluding packing)	6.000 g
Custom tariff number	85364900
Country of origin	Czech Republic

Technical data

Dimensions

Width	5 mm
Height	28 mm
Depth	15 mm

Ambient conditions

Ambient temperature (operation)	-40 °C ... 85 °C
---------------------------------	------------------

Single relay - REL-MR- 4,5DC/21 - 2961367

Technical data

Ambient conditions

Ambient temperature (storage/transport)	-40 °C ... 85 °C
Degree of protection	RT III

Coil side

Nominal input voltage U_N	4.5 V DC
Input voltage range in reference to U_N	see diagram
Typical input current at U_N	38 mA
Typical response time	5 ms
Typical release time	2.5 ms
Coil resistance	119 Ω \pm 10 % (at 20 °C)
Power dissipation for nominal condition	0.17 W

Contact side

Contact type	1 changeover contact
Type of switch contact	Single contact
Contact material	AgSnO
Maximum switching voltage	250 V AC/DC
Minimum switching voltage	5 V (at 100 mA)
Min. switching current	10 mA (at 12 V)
Maximum inrush current	10 A (4 s)
Limiting continuous current	6 A
Interrupting rating (ohmic load) max.	140 W (at 24 V DC)
	20 W (at 48 V DC)
	18 W (at 60 V DC)
	23 W (at 110 V DC)
	40 W (at 220 V DC)
	1500 VA (for 250 V AC)
Switching capacity	2 A (at 24 V, DC13)
	0.2 A (at 110 V, DC13)
	0.1 A (at 220 V, DC13)
	3 A (at 24 V, AC15)
	3 A (at 120 V, AC15)
	3 A (at 230 V, AC15)
Motor load according to UL 508	1/4 HP, 240 - 277 V AC (N/O contact)
	1/6 HP, 240 - 277 V AC (N/C contact)

General

Test voltage	4 kV AC (50 Hz, 1 min., winding/contact)
Operating mode	100% operating factor

Single relay - REL-MR- 4,5DC/21 - 2961367

Technical data

General

Mechanical service life	2x 10 ⁷ cycles
Mounting position	any
Assembly instructions	in rows with zero spacing

Connection data

Connection method	Solder connection
-------------------	-------------------

Standards and Regulations

Connection in acc. with standard	CUL
Standards/regulations	IEC 60664
	EN 50178
	EN 61810-1
Pollution degree	3
Overvoltage category	III

Conformance/approvals

Designation	Corrosive gas test
Identification	ISA-S71.04. G3 Harsh Group
	EN 60068-2-60

Environmental Product Compliance

China RoHS	Environmentally friendly use period: unlimited = EFUP-e
	No hazardous substances above threshold values

Drawings

Diagram

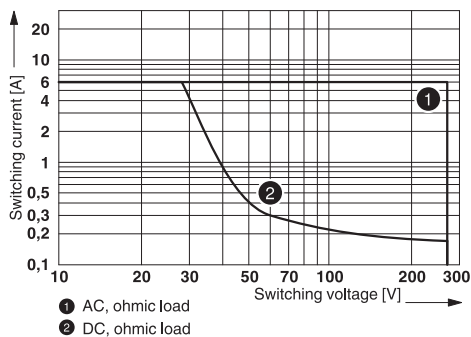

Drilling diagram

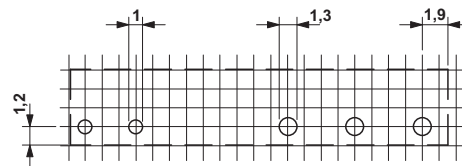

a = pitch division 1.25 mm and 1.27 mm

Interrupting rating

Single relay - REL-MR- 4,5DC/21 - 2961367

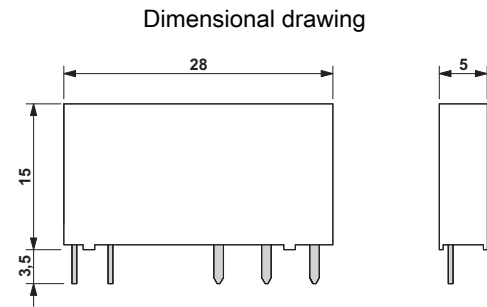
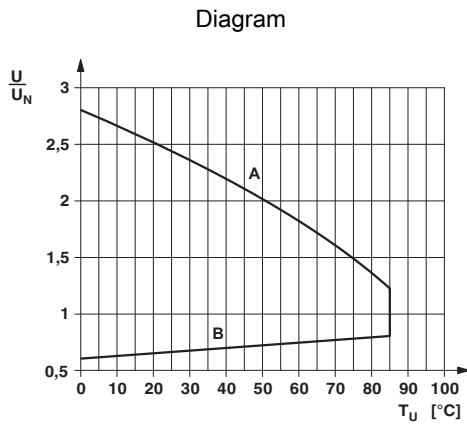

Operating voltage range

Circuit diagram

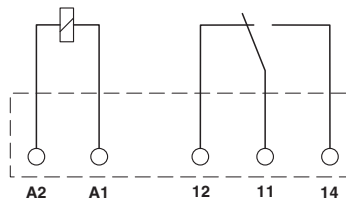

Classifications

eCl@ss

eCl@ss 10.0.1	27371601
eCl@ss 11.0	27371601
eCl@ss 4.0	27371100
eCl@ss 4.1	27371100
eCl@ss 5.0	27371600
eCl@ss 5.1	27371600
eCl@ss 6.0	27371600
eCl@ss 7.0	27371601
eCl@ss 9.0	27371601

ETIM

ETIM 2.0	EC001437
ETIM 3.0	EC001437
ETIM 4.0	EC001437
ETIM 6.0	EC001437

Single relay - REL-MR- 4,5DC/21 - 2961367

Classifications

ETIM

ETIM 7.0	EC001437
----------	----------

UNSPSC

UNSPSC 6.01	30211916
UNSPSC 7.0901	39121515
UNSPSC 11	39121515
UNSPSC 12.01	39121515
UNSPSC 13.2	39122334
UNSPSC 18.0	39122334
UNSPSC 19.0	39122334
UNSPSC 20.0	39122334
UNSPSC 21.0	39122334

Approvals

Approvals

Approvals

PRS / EAC / EAC / UL Recognized / UL Recognized / cUL Recognized / cUL Recognized / VDE Zeichengenehmigung / VDE Zeichengenehmigung

Ex Approvals

Approval details

PRS		http://www.prs.pl/	TE/2109/880590/16
-----	--	---	-------------------

EAC			TR_TS_D_00573_c
-----	--	--	-----------------

EAC			RU*C- DE.*08.B.00010
-----	--	--	-------------------------

Single relay - REL-MR- 4,5DC/21 - 2961367

Approvals

UL Recognized		http://database.ul.com/cgi-bin/XYV/template/LISEXT/1FRAME/index.htm	FILE E 172140
UL Recognized		http://database.ul.com/cgi-bin/XYV/template/LISEXT/1FRAME/index.htm	FILE E 172140
cUL Recognized		http://database.ul.com/cgi-bin/XYV/template/LISEXT/1FRAME/index.htm	FILE E 172140
cUL Recognized		http://database.ul.com/cgi-bin/XYV/template/LISEXT/1FRAME/index.htm	FILE E 172140
VDE Zeichengenehmigung		http://www2.vde.com/de/Institut/Online-Service/VDE-gepruefteProdukte/Seiten/Online-Suche.aspx	40010212
VDE Zeichengenehmigung		http://www2.vde.com/de/Institut/Online-Service/VDE-gepruefteProdukte/Seiten/Online-Suche.aspx	40032864

Accessories

Additional products

Relay base - PLC-BSP- 5DC/21 - 2980238



6.2 mm PLC basic terminal block with spring-cage connection, without relay or solid-state relay, for mounting on DIN rail NS 35/7,5, 1 changeover contact, input voltage 5 V DC

Single relay - REL-MR- 4,5DC/21 - 2961367

Accessories

Relay base - PLC-BSP- 5DC/ 1/ACT - 2980254



6.2 mm PLC basic terminal block for output functions with spring-cage connection, without relay or solid-state relay, for mounting on DIN rail NS 35/7,5, with load return line connection (BB), 1 N/O contact, input voltage 5 V DC

Relay base - PLC-BSC- 5DC/21 - 2980225



6.2 mm PLC basic terminal block with screw connection, without relay or solid-state relay, for mounting on DIN rail NS 35/7,5, 1 changeover contact, input voltage 5 V DC

Relay base - PLC-BSC- 5DC/ 1/ACT - 2980241



6.2 mm PLC basic terminal block for output functions with screw connection, without relay or solid-state relay, for mounting on DIN rail NS 35/7,5, with load return line connection (BB), 1 N/O contact, input voltage 5 V DC

Relay base - PLC-BPT- 5DC/21 - 2900443



6.2 mm PLC basic terminal block with Push-in connection, without relay or solid-state relay, for mounting on DIN rail NS 35/7,5, 1 changeover contact, input voltage 5 V DC

Relay base - PLC-BSC- 5DC/ 1/SEN - 2980267



6.2 mm PLC basic terminal block for output functions with screw connection, without relay or solid-state relay, for mounting on DIN rail NS 35/7,5, with load return line connection (BB), 1 N/O contact, input voltage 5 V DC

Single relay - REL-MR- 4,5DC/21 - 2961367

Accessories

Relay base - PLC-BPT- 5DC/ 1/ACT - 2900448



6.2 mm PLC basic terminal block for output functions with push-in connection, without relay or solid-state relay, for mounting on DIN rail NS 35/7,5, with load return line connection (BB), 1 N/O contact, input voltage 5 V DC